

## Steering Algorithm for Drift Free Control Systems

Fazal-Ur-Rehman, Muhammad Mansoor Ahmed, Syed Abdul Moiz

Mohammad Ali Jinnah University  
Department of Electronic Engineering,  
Jinnah Avenue, Blue Area, Islamabad, Pakistan

**ABSTRACT:** This paper presents a simple steering algorithm for nonholonomic control systems without drift. The effectiveness of the algorithm is tested on four different nonholonomic control systems: a spacecraft, a front wheel drive car, a fire truck model, and a model of mobile robot with trailer. The controllability Lie Algebra of the spacecraft model contains Lie bracket of depth one while the model of a front wheel drive car and a fire truck model contain Lie brackets of depth one and two. The controllability Lie Algebra of the model of mobile robot with trailer contains Lie brackets of depth one, two, and three. The feedback controls are piecewise constant, states dependent and the method is based on the construction of a cost function  $V$  which is sum of the two semi positive definite functions  $V_1$  and  $V_2$ , where  $V_1$  consists of the function of the first  $m$  state variables which can be steered along the given vector fields and  $V_2$  is the function of the remaining  $n - m$  state variables which can be steered along the missing Lie brackets. The values of the functions  $V_1$  and  $V_2$  allow in determining a desired direction of system motion and permit to construct a sequence of controls such that the sum of these functions decreases in an average sense. This approach does not necessitate the conversion of the system model into a "chained form", and thus does not rely on any special transformation techniques.

**Keywords:** systems without drift, nonholonomic systems, controllability Lie algebra, chained form and Lyapunov function.

**AMS Subject classification:** 34K10, 34B15, 34K25

### I. Introduction

The feedback control strategy presented in this paper applies to systems of the type:

$$\dot{z} = \sum_{i=1}^m Z_i(z) u_i, \quad \text{with i.c. } z(0) = z_0, \quad z \in \mathcal{R}^n, \quad m < n \quad (1)$$

where  $Z_i$ ,  $i = 1, 2, \dots, m$ , are linearly independent, smooth vector fields in  $\mathcal{R}^n$ ,  $u_i$  are piecewise continuous and locally bounded in  $t$ , control functions defined on the interval  $[0, \infty)$ . Such systems arise frequently in practice and typically represent models of mechanical systems

with velocity constraints, such as, for example, wheeled vehicles, for which no slipping occurs between the wheels and the contact surface. Such systems are known to be difficult to control as reflected by fact that the linearization of (1) is an uncontrollable system. It is also well known that system (1) cannot be stabilized by continuous, static state feedback see [6]. Hence, a considerable effort has been expended in order to find continuous, time-varying control laws ([1], [3], [7],[14], [15], [16]) discontinuous ones ([2], [8], [12]) as well as mixed strategies ([5],[17]). See [9] and the references therein for a comprehensive survey of the field.

Since discontinuous control is practical in many applications, our interest in this paper is to propose a simple method for the construction of discontinuous feedback control for system (1). The proposed method presents piece-wise constant and states dependent control laws with the objective of steering the system (1) from any arbitrary initial state to any desired state. The approach is based on the construction of a cost function which is a sum of two semi positive definite functions  $V_1(z)$  and  $V_2(z)$ , where  $V_1(z)$  consists of the  $m$  state variables which can be steered along the given vector fields and  $V_2(z)$  is dependent on the remaining  $n-m$  state variables which can be steered along the missing Lie brackets. The values of these functions allow in determining a desired direction of system motion and permit to construct a sequence of controls such that the sum of these functions decreases in an average sense. The individual functions are hence not restricted to decrease monotonically but their oscillations are limited and coordinated in a way to guarantee convergence. The task of the control is to decay the non-differentiable cost function along the controlled system trajectories only asymptotically. This approach does not necessitate conversion of the system model into a “chained form”, and thus does not rely on any special transformation techniques.

## 2. The Control problem and some assumptions

- (SP): Given a desired set point  $z_{des} \in \mathfrak{R}^n$ , construct a discontinuous feedback strategy in terms of the controls  $u_i : \mathfrak{R}^n \rightarrow \mathfrak{R}, i = 1, 2, \dots, m$  such that the desired set point  $z_{des}$  is an attractive set for (1), so that there exists an  $\varepsilon > 0$ , such that  $z(t; 0, z_0) \rightarrow z_{des}$ , as  $t \rightarrow \infty$  for any initial condition  $z_0 \in B(z_{des}; \varepsilon)$ .

Without the loss of generality, it is assumed that  $z_{des} = 0$ , which can be achieved by a suitable translation of the coordinate system. The following assumptions are assumed to hold for these types of systems:

- (A1): The vector fields  $Z_i$ ,  $i = 1, 2, \dots, m$  are linearly independent and contain no singular point for all  $z \in M \subseteq \mathfrak{R}^n$ , where  $M$  is some manifold in  $\mathfrak{R}^n$ .
- (A2): The system (1) satisfies the LARC (Lie algebraic rank condition) for controllability (see [13]), namely that the Lie algebra,  $L(Z_1, \dots, Z_m)(z)$  spans  $\mathfrak{R}^n$  at each point  $z \in M \subseteq \mathfrak{R}^n$  i.e.

$$\text{span}\{Z_i(z), [Z_i, Z_k](z), [Z_i, [Z_j, Z_k]](z), \dots, i, j, k = 1, 2, \dots, m\} = \mathfrak{R}^n \quad (2)$$

- (A3) The state variables  $z_i$ ,  $i = 1, \dots, m$  can be steered along the given vector fields  $Z_i$ ,  $i = 1, \dots, m$  respectively and  $z_r$ ,  $r = m + 1, \dots, n$  can be steered along the missing Lie brackets  $Z_r$ ,  $r = m + 1, \dots, n$  involved in (2), respectively.

### 3. Basic approach to feedback control synthesis

It is clear that for system (1) there does not exist any Lyapunov function  $V$  for which the set

$$S \stackrel{\text{def}}{=} \{z \in \mathfrak{R}^n : L_{Z_i} V(z) = 0, i = 1, \dots, m\} = \{0\} \quad (3)$$

This disables the construction of the control laws  $u_i(z)$ ,  $i = 1, \dots, m$ , which render  $\frac{d}{dt}V(z) < 0$  along the trajectories of the controlled system. A different approach is therefore suggested which relies on the construction of two functions  $V_i(z)$ ,  $i = 1, 2$ , whose behavior along the trajectories of the controlled system is not limited to  $\frac{d}{dt}V_i(z) < 0$ ,  $i = 1, 2$ . While allowing the function  $V_1(z)$  to increase, it is possible to construct feedback controls  $u_i(z)$ ,  $i = 1, \dots, m$ , in such a way that the

sum  $V(z) \stackrel{\text{def}}{=} V_1(z) + V_2(z)$  decreases on average.

#### 3.1 Construction of the cost function and feedback strategy

For the construction of the functions  $V_1(z)$  and  $V_2(z)$  consider the following two groups of vector fields and missing Lie brackets:

$$G_1(z) \stackrel{def}{=} \{Z_1(z), Z_2(z), \dots, Z_m(z)\} \text{ and } G_2(z) \stackrel{def}{=} \{Z_{m+1}(z), \dots, Z_n(z)\}.$$

We introduce the following semi-positive definite functions:

$$V_1(z) \stackrel{def}{=} \frac{1}{2} z^T G_1(0) G_1^T(0) z \text{ and } V_2(z) \stackrel{def}{=} \frac{1}{2} z^T G_2(0) G_2^T(0) z.$$

The cost function is defined as:  $V(z) \stackrel{def}{=} V_1(z) + V_2(z)$ .

The suggested feedback strategy focuses on the decrease in  $V_2$  alone and the solution to the steering problem of system (1) can be obtained by steering the system from any initial state  $z(0)$  to the desired state  $z_{des} = 0$  through a sequence of motions:

$$z(0) \rightarrow S_m \rightarrow S_{m+1} \rightarrow S_{m+2} \dots \rightarrow S_n = \{z_{des} = 0\}$$

where,

$$S_m \stackrel{def}{=} \{z \in \mathfrak{R}^n : z_1 = \dots = z_m = 0 \text{ \& } z_r \neq 0, r = m+1, \dots, n\}$$

$$S_{m+1} \stackrel{def}{=} \{z \in \mathfrak{R}^n : z_1 = \dots = z_{m+1} = 0 \text{ \& } z_r \neq 0, r = m+2, \dots, n\}$$

⋮

$$S_{n-1} \stackrel{def}{=} \{z \in \mathfrak{R}^n : z_1 = \dots = z_{n-1} = 0 \text{ \& } z_n \neq 0\}$$

$$S_n \stackrel{def}{=} \{z \in \mathfrak{R}^n : z_1 = \dots = z_n = 0\}.$$

First of all steer the system (1) from any arbitrary initial state  $z_0$  to the surface  $S_m$  by using the classical controls:  $u_i = -\text{sign}(z_i)$ ,  $i = 1, 2, \dots, m$ . By considering a Lyapunov function:

$$V(z) = \frac{1}{2} \sum_{i=1}^n z_i^2 \text{ we have:}$$

$$\frac{d}{dt} V(z) = \sum_{i=1}^n z_i \dot{z}_i = \sum_{i=1}^m z_i u_i + \sum_{j=m+1}^n z_j \dot{z}_j = -\sum_{i=1}^m |z_i| + \sum_{j=m+1}^n z_j f_j(z, u_i) \begin{cases} < 0 & \text{if } z \in \mathfrak{R}^n \setminus S_m \\ = 0 & \text{if } z \in S_m \end{cases}$$

where  $\dot{z}_j = f_j(z, u_i) = 0$  since  $u_i = 0$  if  $z_i = 0$ .

If  $z \in S_m$  then the above strategy is failed due to the fact that  $\frac{d}{dt} V(z) = 0$ , where as  $z \neq 0$ .

Further decrease in  $V(z)$  is not possible by the classical control law. Note that on the

surface  $S_m$ ,  $V_1(z) = 0$  and  $V_2(z) \neq 0$ . The decrease in  $V_2(z)$  can be achieved by steering the system from  $S_m$  to  $S_{m+1}$  i.e. by steering the state variable  $z_{m+1}$  to zero by generating the motion along the Lie bracket associated with  $z_{m+1}$ .

Let  $z_k$  be the state variable associated with some Lie bracket  $[Z_i, Z_j]$ ,  $z_i$  &  $z_j$  are associated with the given vector fields  $Z_i$  &  $Z_j$  respectively. The following four steps can generate the motion along this Lie bracket:

- (a) Apply the controls:  $u_i(z) = 1$  &  $u_j(z) = 0, \forall j \neq i$  until  $|z_i| \geq |z_k|$ . This step will change  $V_1(z)$  and  $z_i$  from zero to a nonzero value.
- (b) By setting the controls  $u_i(z) = 0 \forall i \neq j$  &  $u_j(z) = -\text{sign}(z_k)$  until  $z_k = 0$ . In this step  $V_2 \downarrow$  and  $z_j$  also becomes nonzero.
- (c) Employ the controls  $u_i = -1, u_j = 0, \forall j \neq i$  until  $z_i = 0$ .
- (d) By setting the controls  $u_i(z) = 0 \forall i \neq j$  &  $u_j(z) = -\text{sign}(z_j)$  until  $z_j = 0$ . This step will give  $V_1(z) = 0$  and will not disturb  $z_k$ .

The steps (a)-(d) will generate the system motion along the Lie bracket  $[Z_i, Z_j]$ . The following examples illustrate the method how to generate system motion along the Lie brackets of depth  $\geq 2$ .

#### 4. Examples

##### 4.1 Example 1: The model of a rigid spacecraft in actuator failure mode

The model of a rigid spacecraft in actuator failure mode represents a three-dimensional nonholonomic control system with control deficiency order one and its controllability algebra contains Lie bracket of depth one. The kinematics model of a model of a rigid spacecraft in actuator failure mode is given as [10]:

$$\dot{z} = Z_1(z) u_1 + Z_2(z) u_2, \quad z \in \mathfrak{R}^3 \quad (4)$$

$$\text{where, } Z_1(z) = \begin{bmatrix} \cos z_2 \\ \sin z_2 \tan z_1 \\ -\sin z_2 \sec z_1 \end{bmatrix}, \quad Z_2(z) = \begin{bmatrix} 0 \\ 1 \\ 0 \end{bmatrix} \text{ and } Z_3(z) \stackrel{\text{def}}{=} [Z_1, Z_2](z) = \begin{bmatrix} \sin z_2 \\ -\cos z_2 \tan z_1 \\ \cos z_2 \sec z_1 \end{bmatrix}.$$

If the motion is restricted to the manifold:  $M = \{z \in \mathfrak{R}^3 : |z_1| < \frac{\pi}{2}\}$  then the LARC (Lie algebraic rank condition) for controllability is satisfied, namely the Lie algebra,  $L(Z_1, Z_2)$  spans  $\mathfrak{R}^3$  at each point  $z \in M$  i.e.

$$\text{span}\{Z_1(z), Z_2(z), Z_3(z)\} = \mathfrak{R}^3 \quad \forall z \in M \subseteq \mathfrak{R}^3 \quad (5)$$

#### 4.1.1 Construction of the cost function and feedback strategy

For the construction of the functions  $V_1(z)$  and  $V_2(z)$  consider the following two groups of vector fields and the missing Lie brackets:

$$G_1(z) \stackrel{\text{def}}{=} \{Z_1(z), Z_2(z)\} \text{ and } G_2(z) \stackrel{\text{def}}{=} \{Z_3(z)\}.$$

We introduce the following semi-positive definite functions:

$$V_1(z) = \frac{1}{2} z^T G_1(0) G_1^T(0) z = \frac{1}{2} (z_1^2 + z_2^2), \quad V_2(z) = \frac{1}{2} z^T G_2(0) G_2^T(0) z = \frac{1}{2} (z_3^2) \text{ and}$$

$$V(z) \stackrel{\text{def}}{=} V_1(z) + V_2(z) = \frac{1}{2} (z_1^2 + z_2^2 + z_3^2).$$

The solution to the steering problem of system (4) can be obtained by steering the system as:

$$z(0) \rightarrow S_2 \rightarrow S_3 = \{z_{des} = 0\}$$

where,  $S_2 \stackrel{\text{def}}{=} \{z \in \mathfrak{R}^3 : z_1 = z_2 = 0 \text{ \& } z_3 \neq 0\}$  and  $S_3 \stackrel{\text{def}}{=} \{z \in \mathfrak{R}^3 : z_1 = z_2 = z_3 = 0\}$ .

#### Steering algorithm for a model of rigid spacecraft in actuator failure mode

- Data:  $\varepsilon > 0$
- [Step 1] Apply the controls:  $u_i = -\text{sign}(z_i)$ ,  $i = 1, 2$  until the system trajectories converge to  $B(S_2; \varepsilon)$ , where,  $S_2 \stackrel{\text{def}}{=} \{z \in \mathfrak{R}^3 : z_1 = z_2 = 0, \quad z_3 \neq 0\}$ . At  $S_2$ ,  $V_1 = 0$  but  $V_2 \neq 0$ .
- [Step 2] Steer the system from  $S_2$  to  $S_3 \stackrel{\text{def}}{=} \{z \in \mathfrak{R}^3 : z_1 = z_2 = z_3 = 0\}$  by generating the system motion along the Lie bracket  $Z_3(z) \stackrel{\text{def}}{=} [Z_1, Z_2](z)$  as:
  - (2a) Apply the controls  $u_1 = 0$  &  $u_2 = 1$  until  $|z_2| \geq |z_3|$ .
 (This step makes  $z_2 \neq 0$  and hence  $V_1 \neq 0$ .)

- (2b) Apply the controls  $u_1 = -\text{sign}(z_3)$  &  $u_2 = 0$  until  $z_3 = 0$ .

(This step makes  $V_2 = 0$  and also gives  $z_1 \neq 0$ .)

- (2c) Steer  $z_2$  to zero by using  $u_1 = 0$  &  $u_2 = -1$ .

- (2d) Apply the controls  $u_1 = -\text{sign}(z_1)$  &  $u_2 = 0$  until  $z_1 = 0$ .

(This step gives  $V_1(z) = 0$  and does not disturb  $z_3$  since in the beginning of this step

$z_2$  &  $z_3 = 0$  and during this step its dynamics is

$$\dot{z}_3 = -\sin z_2 \sec z_1 \Big|_{z_2=0} (-\text{sign}(z_1)) = 0.$$

**Theorem 2**

The above feedback strategy steers the system (4) from any initial state  $z(0)$  to the desired state  $z_{des} = 0$  through a sequence of motions

$$z(0) \xrightarrow{\substack{V_1=0 \\ V_2 \neq 0}} S_2 \xrightarrow{\substack{V_1=0 \\ V_2=0}} S_3 = \{z_{des} = 0\} \text{ i.e. } z(0) = \begin{bmatrix} z_1 \\ z_2 \\ z_3 \end{bmatrix} \xrightarrow{\substack{V_1=0 \\ V_2 \neq 0}} \begin{bmatrix} 0 \\ 0 \\ \times \end{bmatrix} \xrightarrow{\substack{V_1=0 \\ V_2=0}} \begin{bmatrix} 0 \\ 0 \\ 0 \end{bmatrix} = z_{des} \text{ in}$$

finite time.

Simulation results are depicted in Figures 4a – 4d for two different initial conditions.

**4.2. Example 2: The front wheel drive car**

The example considered below represents fourth dimensional nonholonomic control system with control deficiency orders two. Its controllability Lie algebra contains Lie brackets of depth one and two. The kinematics model of a front wheel drive car is given as [11]:

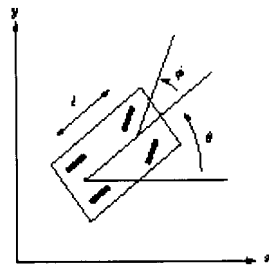


Figure1: A front wheel drive car model

$$\begin{aligned}
\dot{\phi} &= u_1 \\
\dot{x} &= \cos \theta u_2 \\
\dot{y} &= \sin \theta u_2 \\
\dot{\theta} &= \frac{1}{l} \tan \phi u_2
\end{aligned} \tag{6}$$

After redefining the states variables as  $(z_1, z_2, z_3, z_4)^T \stackrel{\text{def}}{=} (\phi, x, y, \theta)^T$  in the kinematics model (6) and assuming  $l=1$  we have the following:

$$\dot{z} = Z_1(z) u_1 + Z_2(z) u_2, \quad z \in \mathfrak{R}^4 \tag{7}$$

$$\text{where, } Z_1(z) = \begin{bmatrix} 1 \\ 0 \\ 0 \\ 0 \end{bmatrix}, \quad Z_2(z) = \begin{bmatrix} 0 \\ \cos z_3 \\ \tan z_1 \\ \sin z_3 \end{bmatrix}.$$

The following Lie brackets:

$$Z_3(z) \stackrel{\text{def}}{=} [Z_1, Z_2](z) = \begin{bmatrix} 0 \\ 0 \\ (\sec z_1)^2 \\ 0 \end{bmatrix}, \quad Z_4(z) \stackrel{\text{def}}{=} [Z_2, [Z_1, Z_2]](z) = \begin{bmatrix} 0 \\ \sin z_3 (\sec z_1)^2 \\ 0 \\ -\cos z_4 (\sec z_1)^2 \end{bmatrix}$$

show that if the motion of the system is restricted to the manifold:  $M = \{z \in \mathfrak{R}^4 : |z_1| < \frac{\pi}{2}\} \stackrel{\text{def}}{}$  then

the LARC condition is satisfied:  $\text{span} \{Z_1(z), Z_2(z), \dots, Z_4(z)\} = \mathfrak{R}^4 \quad \forall z \in M \subseteq \mathfrak{R}^4$ .

#### 4.3.1 Construction of the cost function and feedback strategy

For the construction of the functions  $V_1(z)$  and  $V_2(z)$  consider the following two groups of vector fields and missing Lie brackets:

$$G_1(z) \stackrel{\text{def}}{=} \{Z_1(z), Z_2(z)\} \text{ and } G_2(z) \stackrel{\text{def}}{=} \{Z_3(z), Z_4(z)\}.$$

We introduce the following semi-positive definite functions:

$$V_1(z) = \frac{1}{2} z^T G_1(0) G_1^T(0) z = \frac{1}{2} z^T z = \frac{1}{2} (z_1^2 + z_2^2)$$

$$V_2(z) = \frac{1}{2} z^T G_2(0) G_2^T(0) z = \frac{1}{2} z^T z = \frac{1}{2} (z_3^2 + z_4^2).$$

$$V(z) \stackrel{\text{def}}{=} V_1(z) + V_2(z) = \frac{1}{2} (z_1^2 + z_2^2 + z_3^2 + z_4^2).$$



First of all steer the system (7) from any initial state  $z(0)$  to the surface

$S_2 = \{z \in \mathfrak{R}^4 : z_1 = z_2 = 0 \& z_3, z_4 \neq 0\}$  by using the controls  $u_i = -\text{sign}(z_i)$ ,  $i = 1, 2$ . Further decrease in  $V_2(z)$  can be achieved by steering the system from

$S_2 = \{z \in \mathfrak{R}^4 : z_1 = z_2 = 0 \& z_3, z_4 \neq 0\}$  to  $S_4 = \{z \in \mathfrak{R}^4 : z_1 = z_2 = z_3 = z_4 = 0\}$  by

generating the system motion along the Lie brackets  $Z_3(z) = [Z_1, Z_2](z)$  and

$Z_4(z) = [Z_2, [Z_1, Z_2]](z)$  simultaneously. For this simultaneous motion consider the reduced system of  $z_3$  and  $z_4$ :

$$\begin{aligned} \dot{z}_3 &= v u_2 \\ \dot{z}_4 &= \sin z_3 u_2 \end{aligned} \quad (8)$$

where  $v = \tan z_1$ . Assuming that  $v$  and  $u_2$  are constant and that  $v \neq 0$ , integration of (8) yields:

$$\begin{aligned} z_3(t) &= z_3(0) + t v u_2 \\ z_4(t) &= z_4(0) + \frac{1}{v} [\cos(z_3(0)) - \cos(z_3(0) + v u_2 t)] \\ &= z_4(0) + \frac{1}{v} [\cos(z_3(0)) - \cos(z_3(t))] \end{aligned}$$

where  $z_3(0)$  and  $z_4(0)$  are the initial values of  $z_3(t)$  and  $z_4(t)$ . Clearly if  $z_4(0) \neq 0$  and  $z_3(0) \neq \frac{\pi}{2}$  then the control  $u_2 = -\text{sign}(z_3 v)$ , where

$$v = \frac{1}{z_4(0)} [1 - \cos(z_3(0))] \quad (9)$$

steer  $z_3(t)$  and  $z_4(t)$  exactly to zero in finite time. From (9), we have

$$\frac{1}{z_4(0)} [1 - \cos(z_3(0))] = v = \tan z_1 \Rightarrow z_1 = z_{1_{des}} = \tan^{-1} \left\{ \frac{1 - \cos(z_3(0))}{z_4(0)} \right\}.$$

We can state the following steering algorithm.

#### Steering Algorithm for the front wheel drive car

- Data:  $\varepsilon > 0$

- [Step 1] Apply the controls:  $u_i = -\text{sign}(z_i)$ ,  $i = 1, 2$  until system trajectories converge to

$B(S_2; \mathcal{E})$ , where  $S_2 \stackrel{\text{def}}{=} \{z \in \mathfrak{R}^4 : z_1 = z_2 = 0, z_3, z_4 \neq 0\}$ . At  $S_2$  we have  $V_1(z) = 0$  and  $V_2(z) \neq 0$ .

- [Step2] Steer the system from  $S_2$  to

$\hat{S}_2 \stackrel{\text{def}}{=} \{z \in \mathfrak{R}^4 : z_1 = z_{1_{des}} = \tan^{-1}\{(1 - \cos z_3)/z_4\}, z_2, z_3, z_4 \neq 0\}$  as:

- (2a) Apply by the controls  $u_1 = 1$  &  $u_2 = 1$  until  $|z_1| \geq |z_{1_{des}}|$ . (This step makes  $z_1, z_2 \neq 0$  and hence  $V_1 \neq 0$ .)
- (2b) Apply the controls  $u_1 = -\text{sign}(z_1 - z_{1_{des}})$  &  $u_2 = 0$  until  $z_1 = z_{1_{des}}$ .

- [Step3] Steer the system from  $\hat{S}_2$  to  $\tilde{S}_2 = \{z \in \mathfrak{R}^4 : z_3 = z_4 = 0, z_1, z_2 \neq 0\}$  as:

- Apply the controls:  $u_1 = 0$  &  $u_2 = -\text{sign}(z_3 v)$ , where  $v = \tan(z_{1_{des}})$  until  $z_3 = z_4 = 0$ . (This step gives  $V_2 = 0$ .)

- [Step4] Steer the system from  $\tilde{S}_2$  to  $S_4 = \{z \in \mathfrak{R}^4 : z_1 = z_2 = z_3 = z_4 = 0\}$ :

- (4a) Steer  $z_1$  to zero by using  $u_1 = -1$  &  $u_2 = 0$ .
- (4b) Steer  $z_2$  to zero by using  $u_2 = -\text{sign}(z_2)$  &  $u_1 = 0$ .

(This step gives  $V_1(z) = 0$  and will not disturb  $z_3$  &  $z_4$  since in the beginning of this step

$z_1 = z_3 = z_4 = 0$  and during this step their dynamics are  $\dot{z}_3 = \tan z_1|_{z_1=0} (-\text{sign}(z_2)) = 0$

and  $\dot{z}_4 = \sin z_3|_{z_3=0} (-\text{sign}(z_2)) = 0$ .)

Steps 2-4 generate the system motion along the Lie brackets  $Z_3(z) = [Z_1, Z_2](z)$  and  $Z_4(z) = [Z_2, [Z_1, Z_2]](z)$  simultaneously.

### Theorem 3

The above feedback strategy steers the system (7) from any initial state  $z(0)$  to the desired state  $z_{des} = 0$  through a sequence of motions

$$z(0) \xrightarrow[V_2 \neq 0]{V_1 = 0} S_2 \xrightarrow[V_2 \neq 0]{V_1 \neq 0} \hat{S}_2 \xrightarrow[V_2 = 0]{V_1 \neq 0} \tilde{S}_2 \xrightarrow[V_2 = 0]{V_1 = 0} S_4 = \{z_{des} = 0\}$$

in finite time

$$z(0) = \begin{bmatrix} z_1 \\ z_2 \\ z_3 \\ z_4 \end{bmatrix} \xrightarrow{\substack{V_1=0 \\ V_2 \neq 0}} \begin{bmatrix} 0 \\ 0 \\ \times \\ \times \end{bmatrix} \xrightarrow{\substack{V_1 \neq 0 \\ V_2 \neq 0}} \begin{bmatrix} \times \\ \times \\ \times \\ \times \end{bmatrix} \xrightarrow{\substack{V_1 \neq 0 \\ V_2=0}} \begin{bmatrix} \times \\ \times \\ 0 \\ 0 \end{bmatrix} \xrightarrow{\substack{V_1=0 \\ V_2=0}} \begin{bmatrix} 0 \\ 0 \\ 0 \\ 0 \end{bmatrix} = \{z_{des} = 0\}.$$

Simulation results are depicted in Figures 5a – 5d for two different initial conditions.

**4.4. The fire truck model**

The fire truck is an example of a nonholonomic system with three inputs and six configuration variables, for which the controllability Lie algebra contains two Lie brackets of *depth one* and one Lie bracket of *depth two*. After redefining the states variables as

$(z_1, z_2, z_3, z_4, z_5, z_6)^T \stackrel{def}{=} (x, \phi_0, \phi_1, \theta_0, \theta_1, y)^T$  in the kinematics model of fire truck as given in [4] and assuming  $l_0 = l_1 = 1$  we have following:

$$\dot{z} = Z_1(z)u_1 + Z_2(z)u_2 + Z_3(z)u_3 \tag{10}$$

where,

$$Z_1 = \begin{bmatrix} 1 \\ 0 \\ 0 \\ \tan z_2 \sec z_4 \\ -\sin(z_3 - z_4 + z_5) \sec z_3 \sec z_4 \\ \tan z_4 \end{bmatrix}, \quad Z_2 = \begin{bmatrix} 0 \\ 1 \\ 0 \\ 0 \\ 0 \\ 0 \end{bmatrix}, \quad Z_3 = \begin{bmatrix} 0 \\ 0 \\ 1 \\ 0 \\ 0 \\ 0 \end{bmatrix}$$

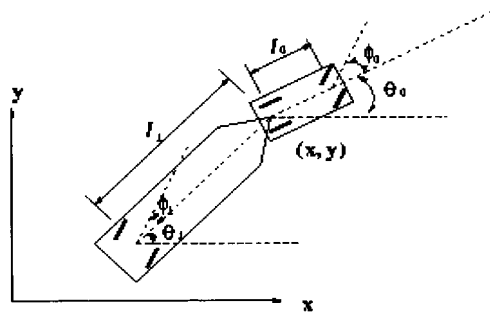


Figure 2: The Fire Truck Model

Calculating the Lie brackets, which are linearly independent at the origin, yields:

$$\begin{aligned}
 Z_4(z) \stackrel{def}{=} [Z_1, Z_2](z) &= \begin{bmatrix} 0 \\ 0 \\ 0 \\ -(\sec z_2)^2 \sec z_4 \\ 0 \\ 0 \end{bmatrix}, \\
 Z_5(z) \stackrel{def}{=} [Z_1, Z_3](z) &= \begin{bmatrix} 0 \\ 0 \\ 0 \\ 0 \\ \sec z_3 \sec z_4 (\cos(z_3 - z_4 + z_5) + \sin(z_3 - z_4 + z_5) \tan z_3) \\ 0 \end{bmatrix}, \\
 Z_6(z) \stackrel{def}{=} [Z_1, [Z_1, Z_2]](z) &= \begin{bmatrix} 0 \\ 0 \\ 0 \\ 0 \\ (\sec z_2 \sec z_4)^2 \sec z_3 (\cos(z_3 - z_4 + z_5) - \sin(z_3 - z_4 + z_5) \tan z_4) \\ (\sec z_2)^2 (\sec z_5)^3 \end{bmatrix}
 \end{aligned}$$

It is clear that, if the motion of the system is restricted to the manifold:

$M \stackrel{def}{=} \{z \in \mathfrak{R}^6 : |z_i| < \frac{\pi}{2}, i = 2, 3, 4\}$  then the LARC condition is satisfied:

$span\{Z_1(z), Z_2(z), \dots, Z_6(z)\} = \mathfrak{R}^6 \quad \forall z \in M$ , hence guaranteeing that the system (10) satisfies the conditions A1 and A2 on the manifold  $M$ .

#### 4.4.1 Construction of the cost function and feedback strategy

For the construction of the functions  $V_1(z)$  and  $V_2(z)$  consider the following two groups of vector fields and missing Lie brackets:

$$G_1(z) \stackrel{def}{=} \{Z_1(z), Z_2(z), Z_3(z)\} \text{ and } G_2(z) \stackrel{def}{=} \{Z_4(z), Z_5(z), Z_6(z)\}.$$

We introduce the following semi-positive definite functions:

$$V_1(z) = \frac{1}{2} z^T G_1(0) G_1^T(0) z = \frac{1}{2} (z_1^2 + z_2^2 + z_3^2),$$

$$V_2(z) = \frac{1}{2} z^T G_2(0) G_2^T(0) z = \frac{1}{2} (z_4^2 + z_5^2 + z_6^2) \text{ and } V(z) \stackrel{def}{=} V_1(z) + V_2(z).$$

$$\text{Define } V_{21}(z) = \frac{1}{2} (z_4^2 + z_6^2), \text{ and } V_{22}(z) = \frac{1}{2} z_5^2 \text{ then } V_2(z) \stackrel{def}{=} V_{21}(z) + V_{22}(z).$$

First of all steer the system (12) from any initial state  $z(0)$  to surface

$$S_3 \stackrel{def}{=} \{z \in \mathfrak{R}^6 : z_1 = z_2 = z_3 = 0 \ \& \ z_4, z_5, z_6 \neq 0\} \text{ by using the controls}$$

$u_i = -\text{sign}(z_i)$ ,  $i = 1, 2, 3$ . For further decrease in  $V_2(z)$  first steer the system from

$$S_3 \stackrel{def}{=} \{z \in \mathfrak{R}^6 : z_1 = z_2 = z_3 = 0 \ \& \ z_4, z_5, z_6 \neq 0\} \text{ to}$$

$\hat{S}_3 \stackrel{def}{=} \{z \in \mathfrak{R}^6 : z_3 = z_4 = z_6 = 0 \ \& \ z_1, z_2, z_5 \neq 0\}$  which is equivalent to generating the system motion along the Lie brackets  $Z_4(z) = [Z_1, Z_2](z)$  and

$Z_6(z) = [Z_1, [Z_1, Z_2]](z)$  simultaneously. For this consider the reduced system which consists of  $z_4$  and  $z_6$ :

$$\begin{aligned} \dot{z}_4 &= \nu u_1 \\ \dot{z}_6 &= \tan z_4 u_1 \end{aligned} \quad (11)$$

where  $\nu = \tan z_2 \sec z_4$ . Assuming that  $\nu$  and  $u_1$  are constant and that  $\nu \neq 0$ , integration of (11) yields:

$$\begin{aligned} z_4(t) &= z_4(0) + t \nu u_1 \\ z_6(t) &= z_6(0) + \frac{1}{\nu} [\ln \cos(z_4(0)) - \ln \cos(z_4(0) + \nu u_1 t)] \end{aligned} \quad (12)$$

where  $z_4(0)$  and  $z_6(0)$  are the initial values of  $z_4(t)$  and  $z_6(t)$ . Clearly if  $z_6(0) \neq 0$  and

$z_4(0) \neq \frac{\pi}{2}$  then the control  $u_1 = -\text{sign}(z_4 \nu)$ , where

$$\nu = -\frac{1}{z_6(0)} [\ln \cos(z_4(0))] \quad (13)$$

steer  $z_4(t)$  and  $z_6(t)$  exactly to zero in finite time. From (13), we have

$$-\frac{1}{z_6(t)} [\ln \cos(z_4(t))] = \nu = \tan z_2 \sec z_4 \Rightarrow z_2 \stackrel{def}{=} z_{2_{des}} = -\tan^{-1} \left\{ \cos z_4 \frac{\ln \cos(z_4(t))}{z_6(t)} \right\}.$$

### Steering algorithm for the fire truck model

- Data:  $\varepsilon > 0$
- [Step1] Apply the controls:  $u_i = -\text{sign}(z_i)$ ,  $i = 1, 2, 3$  until the system trajectories converge to  $B(S_3; \varepsilon)$ , where  $S_3 \stackrel{\text{def}}{=} \{z \in M \subseteq \mathfrak{R}^6 : z_1 = z_2 = z_3 = 0, z_4, z_5, z_6 \neq 0\}$ . At  $S_3$ ,  $V_1 = 0$  and  $V_2 \neq 0$ .

- [Step2] Steer the system from  $S_3$  to

$$\hat{S} \stackrel{\text{def}}{=} \{z \in \mathfrak{R}^6 : z_3 = 0, z_2 = z_{2_{des}} \stackrel{\text{def}}{=} -\tan^{-1}\left\{\cos z_4 \frac{\ln \cos(z_4(t))}{z_6(t)}\right\}, z_1, z_4, z_5, z_6 \neq 0\} \text{ as:}$$

- (2a) Apply the controls  $u_1 = -1, u_2 = -1$  &  $u_3 = 0$  until  $|z_2| \geq |z_{2_{des}}|$ , where,  $z_{2_{des}} \stackrel{\text{def}}{=} -\tan^{-1}\left\{\cos z_4 \frac{\ln \cos(z_4(t))}{z_6(t)}\right\}$ . (This step makes  $z_1, z_2 \neq 0$  and hence  $V_1 \neq 0$ .)

- (2b) Apply the controls  $u_2 = -\text{sign}(z_2 - z_{2_{des}})$  &  $u_1 = u_3 = 0$  until  $z_2 = z_{2_{des}}$ .

- [Step3] Steer the system from  $\hat{S}$  to

$$\tilde{S}_3 \stackrel{\text{def}}{=} \{z \in M \subseteq \mathfrak{R}^6 : z_3 = z_4 = z_6 = 0, z_1, z_2, z_5 \neq 0\} \text{ as:}$$

- Apply the controls:  $u_1 = -\text{sign}(z_4 v)$  &  $u_2 = u_3 = 0$  until  $z_4 = z_6 = 0$ , where,  $v = \tan z_{2_{des}} \sec z_4$ . (This step gives  $V_{21} = 0$ .)

- [Step4] Steer the system from  $\tilde{S}_3$  to

$$S_5 \stackrel{\text{def}}{=} \{z \in M \subseteq \mathfrak{R}^6 : z_1 = z_2 = z_3 = z_4 = z_6 = 0, z_5 \neq 0\} \text{ as:}$$

- (4a) Steer  $z_2$  to zero by using  $u_2 = -\text{sign}(z_2)$  &  $u_1 = u_3 = 0$ .
- (4b) Steer  $z_3$  to zero by using  $u_1 = -\text{sign}(z_1)$  &  $u_2 = u_3 = 0$ .

(This step gives  $V_1(z) = 0$  and does not disturb  $z_4$  &  $z_6$  since in the beginning of this step  $z_2 = z_4 = z_6 = 0$  and during this step their dynamics

$$\text{are } \dot{z}_4 = \tan z_2 \sec z_4 \Big|_{z_2=0} (-\text{sign}(z_1)) = 0 \text{ and } \dot{z}_6 = \tan z_4 \Big|_{z_4=0} (-\text{sign}(z_1)) = 0.)$$

Steps 2-4 generate the system motion along the Lie brackets  $Z_4(z) = [Z_1, Z_2](z)$  and  $Z_6(z) = [Z_1, [Z_1, Z_2]](z)$  simultaneously.

• [Step5] Steer the system from  $S_5$  to  $S_6 \stackrel{def}{=} \{z \in M \subseteq \mathfrak{R}^6 : z_1 = z_2 = z_3 = z_4 = z_5 = z_6 = 0\}$  by generating the system motion along the Lie bracket  $Z_5(z) = [Z_1, Z_3](z)$  as:

- (5a) Apply the controls  $u_1 = u_2 = 0 \& u_3 = 1$  until  $|z_3| \geq |z_5|$ .

(This step makes  $z_3 \neq 0$  and hence  $V_1 \neq 0$ .)

- (5b) Apply the controls  $u_1 = -sign(z_5) \& u_2 = u_3 = 0$  until  $z_5 = 0$ .

(This step gives  $V_{22} = 0$  and also makes  $z_1 \neq 0$  and do not disturb  $z_4 \& z_6$  since in the beginning of this step  $z_2 = z_4 = z_6 = 0$  and during this step their dynamics are  $\dot{z}_4 = \tan z_2 \sec z_4 |_{z_2=0} (-sign(z_5)) = 0$  and  $\dot{z}_6 = \tan z_4 |_{z_4=0} (-sign(z_5)) = 0$ .)

- (5c) Steer  $z_3$  to zero position by using  $u_1 = u_2 = 0 \& u_3 = -1$

- (5d) Steer  $z_1$  to zero position by using  $u_1 = -sign(z_1) \& u_2 = u_3 = 0$ .

(This step gives  $V_1(z) = V_2(z) = 0$  and does not disturb  $z_4, z_5 \& z_6$  since in the beginning of this step  $z_2 = z_3 = z_4 = z_5 = z_6 = 0$  and during this step their dynamics

are  $\dot{z}_4 = \tan z_2 \sec z_4 |_{z_2=0} (-sign(z_1)) = 0$ ,  $\dot{z}_6 = \tan z_4 |_{z_4=0} (-sign(z_1)) = 0$  and

$\dot{z}_5 = -\sin(z_3 - z_4 + z_5) |_{z_3=z_4=z_5=0} \sec z_3 \sec z_4 (-sign(z_1)) = 0$ .)

**Theorem 6**

The above feedback strategy steer the system (10) from any initial state  $z(0)$  to the desired state  $z_{des} = 0$  through a sequence of motions

$$z(0) \xrightarrow[V_2 \neq 0]{V_1=0} S_3 \xrightarrow[V_2 \neq 0]{V_1 \neq 0} \hat{S} \xrightarrow[V_{21} \neq 0, V_{22} \neq 0]{V_1 \neq 0} \tilde{S}_3 \xrightarrow[V_{21} \neq 0, V_{22} \neq 0]{V_1=0} S_5 \xrightarrow[V_{21} = V_{22} = 0]{V_1=0} S_6 = \{z_{des} = 0\}$$

in finite

$$z(0) = \begin{bmatrix} z_1 \\ z_2 \\ z_3 \\ z_4 \\ z_5 \\ z_6 \end{bmatrix} \xrightarrow[V_2 \neq 0]{V_1=0} \begin{bmatrix} 0 \\ 0 \\ 0 \\ \times \\ \times \\ \times \end{bmatrix} \xrightarrow[V_2 \neq 0]{V_1 \neq 0} \begin{bmatrix} \times \\ z_{2_{des}} \\ 0 \\ \times \\ \times \\ \times \end{bmatrix} \xrightarrow[V_{22} \neq 0]{V_1 \neq 0, V_{21}=0} \begin{bmatrix} \times \\ z_{2_{des}} \\ 0 \\ 0 \\ \times \\ 0 \end{bmatrix} \xrightarrow[V_{22} \neq 0]{V_1=0, V_{21}=0} \begin{bmatrix} 0 \\ 0 \\ 0 \\ 0 \\ \times \\ 0 \end{bmatrix} \xrightarrow[V_2=0]{V_1=0} \begin{bmatrix} 0 \\ 0 \\ 0 \\ 0 \\ 0 \\ 0 \end{bmatrix} = \{z_{des} = 0\}$$

Simulation results are depicted in Figures 6a – 6d for two different initial conditions.

### 4.3. Example3: The mobile robot with trailer model

The example considered below represents a fifth dimensional system with control deficiency order three, possessing a non-nilpotent controllability Lie algebra which contains Lie brackets of depth one, two, and three. Although, the algebraic structure of mobile robot with trailer is more complicated, the decomposition idea can still be employed successfully.

The kinematics model of a mobile robot with trailer (see [11]), is given below:

$$\begin{aligned}
 \dot{x}_1 &= \cos x_3 \cos x_4 u_1 \\
 \dot{x}_2 &= \cos x_3 \sin x_4 u_1 \\
 \dot{x}_3 &= u_2 \\
 \dot{x}_4 &= \frac{1}{l} \sin x_3 u_1 \\
 \dot{x}_5 &= \frac{1}{d} \sin(x_4 - x_5) \cos x_3 u_1
 \end{aligned} \tag{14}$$

and can be suitably re-written by defining  $(x_1, x_2, x_3, x_4, x_5) \stackrel{\text{def}}{=} (z_1, z_4, z_2, z_3, z_5)$ :

$$\dot{z} = Z_1(z)u_1 + Z_2(z)u_2, \quad z \in \mathcal{R}^5 \tag{15}$$

$$\text{where, } Z_1(z) = \begin{bmatrix} \cos z_3 \cos z_2 \\ 0 \\ \sin z_2 \\ \cos z_2 \sin z_3 \\ \cos z_2 \sin(z_3 - z_5) \end{bmatrix}, \quad Z_2(z) = \begin{bmatrix} 0 \\ 1 \\ 0 \\ 0 \\ 0 \end{bmatrix}$$

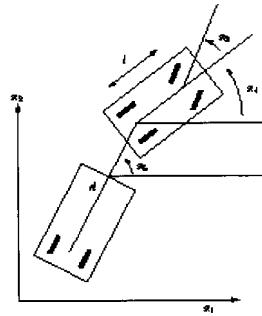


Figure 3: Mobile robot with trailer

The following Lie brackets:



$$Z_3(z) \stackrel{\text{def}}{=} [Z_1, Z_2](z) = \begin{bmatrix} -\sin z_2 \cos z_3 \\ 0 \\ \cos z_2 \\ -\sin z_2 \sin z_3 \\ -\sin z_2 \sin(z_3 - z_5) \end{bmatrix}, \quad Z_4(z) \stackrel{\text{def}}{=} [Z_1, [Z_1, Z_2]](z) = \begin{bmatrix} -\sin z_3 \\ 0 \\ 0 \\ \cos z_3 \\ \cos(z_3 - z_5) \end{bmatrix},$$

$$Z_5(z) \stackrel{\text{def}}{=} [Z_1, [Z_1, [Z_1, Z_2]]](z) = \begin{bmatrix} \sin z_2 \cos z_3 \\ 0 \\ 0 \\ \sin z_2 \sin z_3 \\ \sin z_2 \sin(z_3 - z_5) + \cos z_2 \end{bmatrix}$$

show that the LARC condition is satisfied:  $\text{span} \{Z_1(z), Z_2(z), \dots, Z_5(z)\} = \mathfrak{R}^5 \quad \forall z \in \mathfrak{R}^5$ .

#### 4.5.1 Construction of the cost function and feedback strategy

For the construction of the functions  $V_1(z)$  and  $V_2(z)$  consider the following two groups of vector fields and missing Lie brackets:

$$G_1(z) \stackrel{\text{def}}{=} \{Z_1(z), Z_2(z)\} \quad \text{and} \quad G_2(z) \stackrel{\text{def}}{=} \{Z_3(z), Z_4(z), Z_5(z)\}.$$

We introduce the following semi-positive definite functions:

$$V_1(z) = \frac{1}{2} z^T G_1(0) G_1^T(0) z = \frac{1}{2} (z_1^2 + z_2^2), \quad V_2(z) = \frac{1}{2} z^T G_2(0) G_2^T(0) z = \frac{1}{2} (z_3^2 + z_4^2 + z_5^2)$$

$$\text{and } V(z) \stackrel{\text{def}}{=} V_1(z) + V_2(z).$$

$$\text{Define } V_{21}(z) = \frac{1}{2} (z_3^2 + z_4^2), \quad \text{and } V_{22}(z) = \frac{1}{2} z_5^2 \quad \text{then } V_2(z) \stackrel{\text{def}}{=} V_{21}(z) + V_{22}(z).$$

First of all steer the system (15) from any initial state  $z(0)$  to surface

$$S_2 \stackrel{\text{def}}{=} \{z \in \mathfrak{R}^5 : z_1 = z_2 = 0 \ \& \ z_3, z_4, z_5 \neq 0\} \text{ by using the controls}$$

$u_1 = -\text{sign}(z_1)$  &  $u_2 = -\text{sign}(z_2)$ . For further decrease in  $V_2(z)$  can be achieved by steering the

system from  $S_2 \stackrel{\text{def}}{=} \{z \in \mathfrak{R}^5 : z_1 = z_2 = 0 \ \& \ z_3, z_4, z_5 \neq 0\}$  to

$$\hat{S}_2 \stackrel{\text{def}}{=} \{z \in \mathfrak{R}^5 : z_3 = z_4 = 0 \ \& \ z_1, z_2, z_5 \neq 0\} \text{ by generating the system motion along the Lie}$$

brackets  $Z_3(z) = [Z_1, Z_2](z)$  and  $Z_4(z) = [Z_1, [Z_1, Z_2]](z)$  simultaneously. For this

simultaneously motion consider the reduced system which consists of  $z_3$  and  $z_4$ :

$$\begin{aligned}\dot{z}_3 &= \nu u_1 \\ \dot{z}_4 &= \cos z_2 \sin z_3 u_1 = \sqrt{1-\nu^2} \sin z_3 u_1\end{aligned}\quad (16)$$

where  $\nu = \sin z_2$ . Assuming that  $\nu$  and  $u_1$  are constant and that  $\nu \neq 0$ , integration of (16) yields:

$$\begin{aligned}z_3(t) &= z_3(0) + t \nu u_1 \\ z_4(t) &= z_4(0) + \frac{\sqrt{1-\nu^2}}{\nu} [\cos(z_3(0)) - \cos(z_3(t) + \nu u_1 t)]\end{aligned}$$

where  $z_3(0)$  and  $z_4(0)$  are the initial values of  $z_3(t)$  and  $z_4(t)$ . Clearly if  $z_3(0) \neq 0$  and  $z_4(0) \neq 0$  then  $u_1 = -\text{sign}(z_3 \hat{\nu})$ , where

$$\hat{\nu} \stackrel{\text{def}}{=} \frac{\nu}{\sqrt{1-\nu^2}} = \frac{1}{z_4(0)} [1 - \cos(z_3(0))] \quad (17)$$

steer  $z_3(t)$  and  $z_4(t)$  exactly to zero in finite time. From (17), we have

$$\frac{1}{z_4(0)} [1 - \cos(z_3(0))] = \frac{\nu}{\sqrt{1-\nu^2}} = \tan z_2 \Rightarrow z_2 \stackrel{\text{def}}{=} z_{2_{des}} = \tan^{-1} \left\{ \frac{1 - \cos(z_3(0))}{z_4(0)} \right\}.$$

### Steering algorithm for the mobile robot with trailer model

- Data:  $\varepsilon > 0$
- [Step1] Apply the controls:  $u_1 = -\text{sign}(z_1)$  &  $u_2 = -\text{sign}(z_2)$  until the system trajectories converge to  $B(S_2; \varepsilon)$ , where  $S_2 \stackrel{\text{def}}{=} \{z \in \mathfrak{R}^5 : z_1 = z_2 = 0, z_3, z_4, z_5 \neq 0\}$ . At  $S_2$ ,  $V_1 = 0$  and  $V_2 \neq 0$ .
- [Step2] Steer the system from  $S_2 \stackrel{\text{def}}{=} \{z \in \mathfrak{R}^5 : z_1 = z_2 = 0, z_3, z_4, z_5 \neq 0\}$  to  $\hat{S}_2 \stackrel{\text{def}}{=} \{z \in \mathfrak{R}^5 : z_2 = z_{2_{des}} = \tan^{-1} \left\{ \frac{1 - \cos(z_3(0))}{z_4(0)} \right\}, z_1, z_3, z_4, z_5 \neq 0\}$  as:
  - (2a) Apply the controls  $u_1 = 1$  &  $u_2 = -1$  until  $|z_2| \geq |z_{2_{des}}|$ . (This step makes  $z_1, z_2 \neq 0$  and hence  $V_1 \neq 0$ .)
  - (2b) Apply the controls  $u_1 = 0$  &  $u_2 = -\text{sign}(z_2 - z_{2_{des}})$  until  $z_2 = z_{2_{des}}$ .
- [Step3] Steer the system from  $\hat{S}_2$  to  $\tilde{S}_2 \stackrel{\text{def}}{=} \{z \in \mathfrak{R}^5 : z_3 = z_4 = 0, z_1, z_2, z_5 \neq 0\}$  as:

- Apply the controls:  $u_1 = -\text{sign}(z_3 \hat{v})$  &  $u_2 = 0$  until  $z_3 = z_4 = 0$ , where,

$$\hat{v} = \frac{v}{\sqrt{1-v^2}} = \tan z_{2des}. \quad (\text{This step gives } z_3 = z_4 = 0 \text{ \& } V_{2_1} = 0.)$$

- [Step4] Steer the system from  $\tilde{S}_2$  to  $S_5 \stackrel{def}{=} \{z \in \mathfrak{R}^5 : z_1 = z_2 = z_3 = z_4 = 0, z_5 \neq 0\}$  as:

- (4a) Steer  $z_2$  to zero by using  $u_1 = 0$  &  $u_2 = -\text{sign}(z_2)$ .

- (4b) Steer  $z_1$  to zero by using  $u_1 = -\text{sign}(z_1)$  &  $u_2 = 0$ .

(This step gives  $V_1(z) = 0$  and does not disturb  $z_3$  &  $z_4$  since in the beginning of this step  $z_2 = z_3 = z_4 = 0$  and during this step their dynamics are

$$\dot{z}_3 = \sin z_2 |_{z_2=0} (-\text{sign}(z_1)) = 0 \text{ and } \dot{z}_4 = \cos z_2 \sin z_3 |_{z_3=0} (-\text{sign}(z_1)) = 0.)$$

Steps 2-4 generate the system motion along the Lie brackets  $Z_3(z) = [Z_1, Z_2](z)$  and  $Z_4(z) = [Z_1, [Z_1, Z_2]](z)$  simultaneously.

- [Step5] Steer the system from  $S_4$  to  $S_5 \stackrel{def}{=} \{z \in \mathfrak{R}^5 : z_1 = z_2 = z_3 = z_4 = z_5 = 0\}$  by generating the system motion along the Lie bracket  $Z_5(z) = [Z_1, [Z_1, [Z_1, Z_2]]](z)$  as:

- (5a) Apply the controls  $u_1 = 0$  &  $u_2 = 1$  until  $z_2 = \pi$ .

(This step makes  $z_2 \neq 0$  and hence  $V_1 \neq 0$ .)

- (5b) Apply the controls  $u_1 = -\text{sign}(z_5)$  &  $u_2 = 0$  until  $z_5 = 0$ .

(This step gives  $V_{2_2} = 0$  and also makes  $z_1 \neq 0$  and does not disturb  $z_3$  &  $z_4$  since in the beginning of this step  $z_3 = z_4 = z_5 = 0$  and during this step their dynamics are  $\dot{z}_3 = \sin z_2 |_{z_2=\pi} (-\text{sign}(z_5)) = 0$  and  $\dot{z}_4 = \cos z_2 \sin z_3 |_{z_3=0} (-\text{sign}(z_5)) = 0$ .)

- (5c) Steer  $z_2$  to zero position by using  $u_1 = 0$  &  $u_2 = -1$

- (5d) Steer  $z_1$  to zero position by using  $u_1 = -\text{sign}(z_1)$  &  $u_2 = 0$ .

(This step gives  $V_1(z) = V_2(z) = 0$  and does not disturb  $z_3, z_4$  &  $z_5$  since in the beginning of this step  $z_2 = z_3 = z_4 = z_5 = 0$  and during this step their dynamics are  $\dot{z}_3 = \sin z_2 |_{z_2=0} (-\text{sign}(z_1)) = 0$ ,  $\dot{z}_4 = \cos z_2 \sin z_3 |_{z_3=0} (-\text{sign}(z_1)) = 0$ .) and  $\dot{z}_5 = \sin(z_4 - z_5) \cos z_3 |_{z_4=z_5=0} (-\text{sign}(z_1)) = 0$ .)

**Theorem 6**

The above feedback strategy steer the system (15) from any initial state  $z(0)$  to the desired state  $z_{des} = 0$  through a sequence of motions

$$z(0) \xrightarrow{\substack{V_1=0 \\ V_2 \neq 0}} S_2 \xrightarrow{\substack{V_1 \neq 0 \\ V_2 \neq 0}} \hat{S}_2 \xrightarrow{\substack{V_1 \neq 0 \\ V_{21}=0, V_{22} \neq 0}} \tilde{S}_2 \xrightarrow{\substack{V_1=0 \\ V_{21}=0, V_{22} \neq 0}} S_4 \xrightarrow{\substack{V_1=0 \\ V_{21}=V_{22}=0}} S_5 = \{z_{des} = 0\}$$

in finite

$$z(0) = \begin{bmatrix} z_1 \\ z_2 \\ z_3 \\ z_4 \\ z_5 \end{bmatrix} \xrightarrow{\substack{V_1=0 \\ V_2 \neq 0}} \begin{bmatrix} 0 \\ 0 \\ \times \\ \times \\ \times \end{bmatrix} \xrightarrow{\substack{V_1 \neq 0 \\ V_2 \neq 0}} \begin{bmatrix} \times \\ z_{2_{des}} \\ \times \\ \times \\ \times \end{bmatrix} \xrightarrow{\substack{V_1 \neq 0 \\ V_{21}=0, \\ V_{22} \neq 0}} \begin{bmatrix} \times \\ z_{2_{des}} \\ 0 \\ 0 \\ \times \end{bmatrix} \xrightarrow{\substack{V_1=0 \\ V_{21}=0, \\ V_{22} \neq 0}} \begin{bmatrix} 0 \\ 0 \\ 0 \\ 0 \\ \times \end{bmatrix} \xrightarrow{\substack{V_1=0 \\ V_2=0}} \begin{bmatrix} 0 \\ 0 \\ 0 \\ 0 \\ 0 \end{bmatrix} = \{z_{des} = 0\}$$

Simulation results are depicted in Figures 7a – 7d for two different initial conditions.

**5. Conclusion**

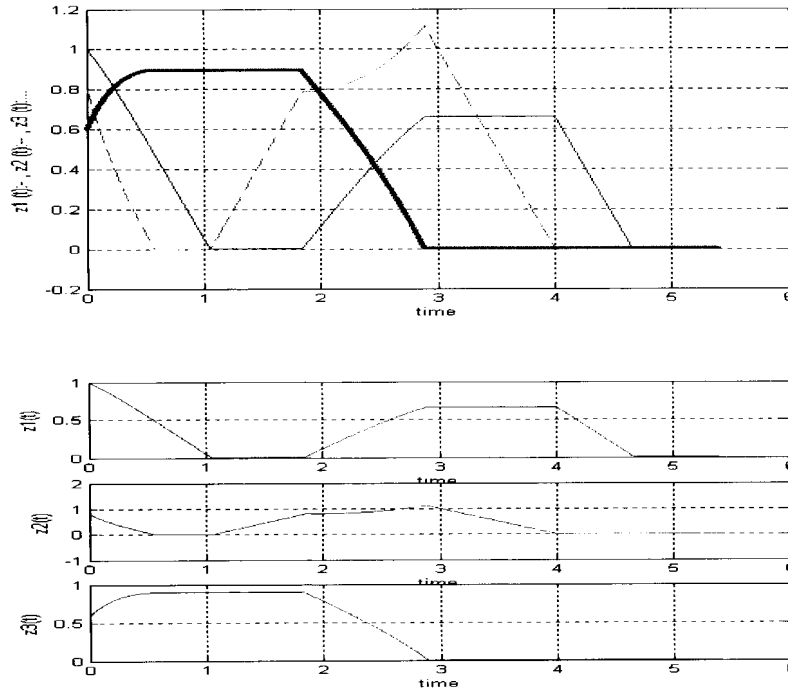
A systematic method for the construction of steering control for nonholonomic systems is introduced with out transforming into “chain form”, and the conditions are stated which guarantee that the resulting feedback control strategy yields global asymptotic convergence to the origin. The approach is applied to steer a spacecraft model, a front wheel drive car, and a fire truck model and the mobile robot with trailer model. This method is general and can be employed to steer a variety of mechanical systems with velocity constraints.

**References**

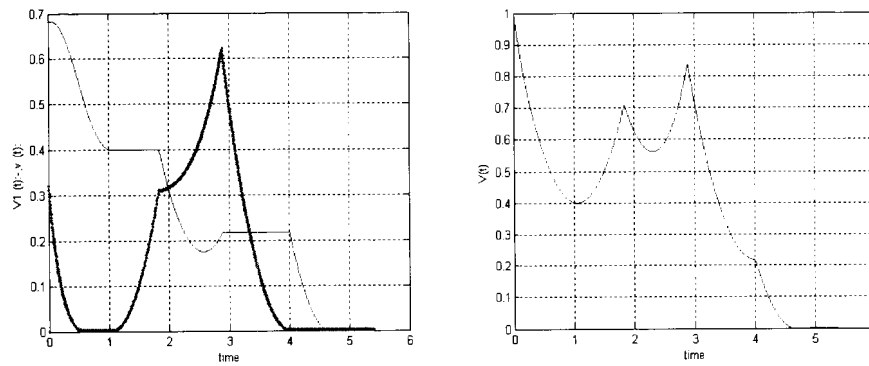
- [1] Alonge F. D’Ippolito F. and Raimondi F. Trajectory tracking of underactuated underwater vehicles, In Proc. 40<sup>th</sup> IEEE Conference on Decision and Control, Orlando, Florida, December, 2001.
- [2] A. Astolfi, Discontinuous control of the Brockett integrator, European Journal of Control 4 (1998), no. 1, 49-63.
- [3] A. Behal, D. Dawson, W. Dixon, and Y. Fang. “Tracking and regulation control of an underactuated surface vessel with nonintegrable dynamics. IEEE Trans. On Auto. Control, 47(3): 495-500, March 2002.
- [4] L. Bushnell, D. Tilbury and S. S. Sastry, “Steering three input chained form nonholonomic Systems using sinusoid: The fire truck example”, European Control Conference, pp. 1432-1437, 1993.

- [5] M. S. Branicky, Multiple Lyapunov functions and other analysis tools for switched and hybrid systems, *IEEE Transactions on Automatic Control* 43 (1998), no. 4, 475-482.
- [6] R. W. Brockett, Asymptotic stability and feedback stabilization, *Differential Geometric Control Theory* (Birkhauser, Boston, USA) (R. W. Brockett, R. S. Millman, and H. J. Sussman, eds.), 1983, pp. 181-191.
- [7] J. M. Godhavn and O. Egeland, A Lyapunov approach to exponential stabilization of nonholonomic systems in power form, *IEEE Transaction on Automatic Control* 42 (1997), no. 7, 1028-1032.
- [8] J. Guldner and V.I. Utkin, Stabilization of nonholonomic mobile robots using Lyapunov functions for navigation and sliding mode control (Orlando, Florida, USA), December 1994, pp. 2967-2972.
- [9] I. Kolmanovsky and N. H. McClamroch, Developments in nonholonomic control problems, *IEEE Control Systems Magazine* 15 (1995), 20-36.
- [10] Krishnan H., M. Reyhanoglu and H. McClamroch, "Attitude stabilization of rigid spacecraft using two control torques: a nonlinear control approach based on the spacecraft attitude dynamics", *Automatica*, V 30, pp. 1023-1027, 1994.
- [11] G. Lafferriere, H. Sussman, "A differential geometric approach to motion planning", in *Nonholonomic Motion Planning* ed. by Z. Li, and J. F. Canny, Kluwer, 1993, pp. 235-270.
- [12] P. Lucibello and G. Oriolo, Robust stabilization via iterative state steering with application to chained-form systems," *Automatica*, vol. 37, no. 1, pp. 71-79, 2001.
- [13] R. M. Murray, Z. Li and S. S. Sastry, "A Mathematical Introduction to Robotic Manipulation", CRC Press, 1994.
- [14] P. Morin and C. Samson, Control of nonlinear chained systems: From the routh-hurwitz stability criterion to time-varying exponential stabilizers, *IEEE Transactions on Automatic Control* 45 (2000), no. 1, 141-146.
- [15] J. B. Pomet, Explicit design of time-varying stabilizing control laws for a class of controllable systems without drift, *Systems and Control Letters* 18 (1992), 147-158.
- [16] M. Vendittelli and G. Oriolo, "Stabilization of the general two trailer system", in *Proc. 2000 IEEE Int. Con. Robot. Automat.* San Francisco, CA, 2000, pp 1817-1823.
- [17] H. Ye, A. N. Michel, and L. Hou, Stability theory for hybrid dynamical systems, *IEEE Transaction on Automatic Control* 43 (1998), no. 4, 461-474.

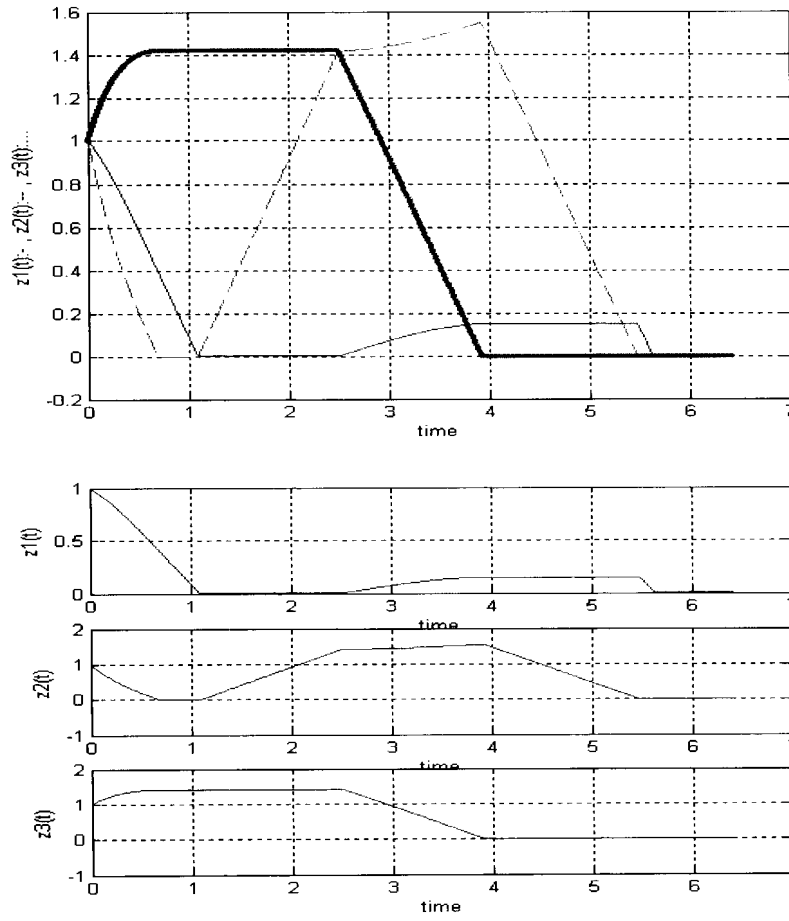
**Simulation results of Example 1(space craft model in actuator failure mode)**



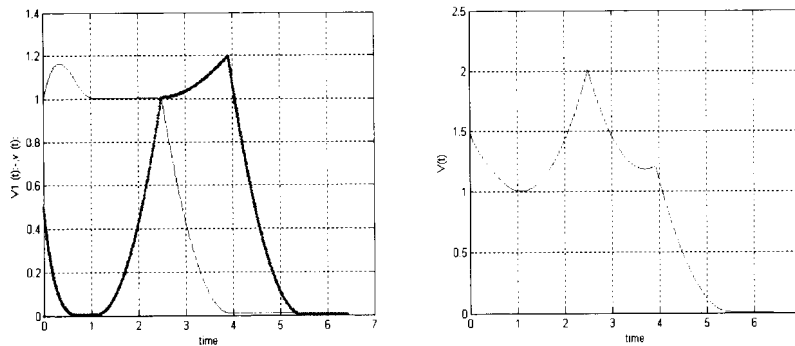
**Figure 4a:** Plots of the controlled state trajectories  $t \mapsto (z_1(t), \dots, z_3(t))$  versus time.



**Figure 4b:** Plots of the functions  $V_1(t)$  &  $V_2(t)$  , and  $V(t)$  versus time.

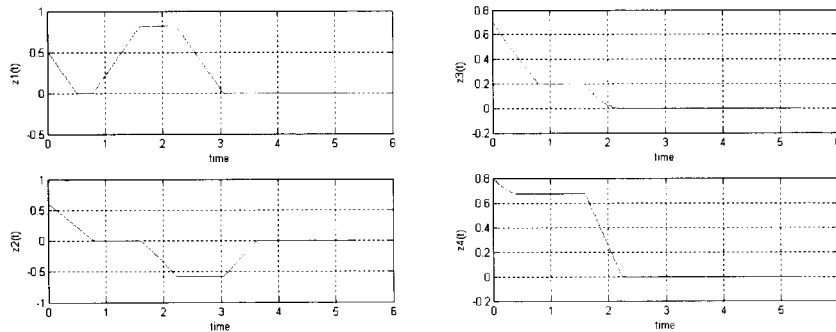
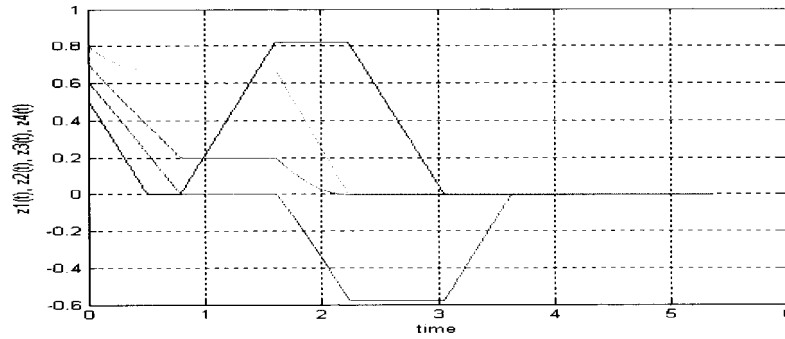


**Figure 4c:** Plots of the controlled state trajectories  $t \mapsto (z_1(t), \dots, z_3(t))$  versus time.

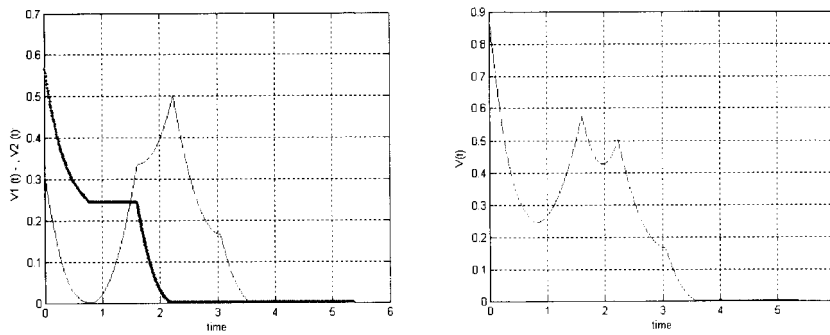


**Figure 4d:** Plots of the functions  $V_1(t)$  &  $V_2(t)$ , and  $V(t)$  versus time.

**Simulation results of Example 2(front wheel drive car model)**

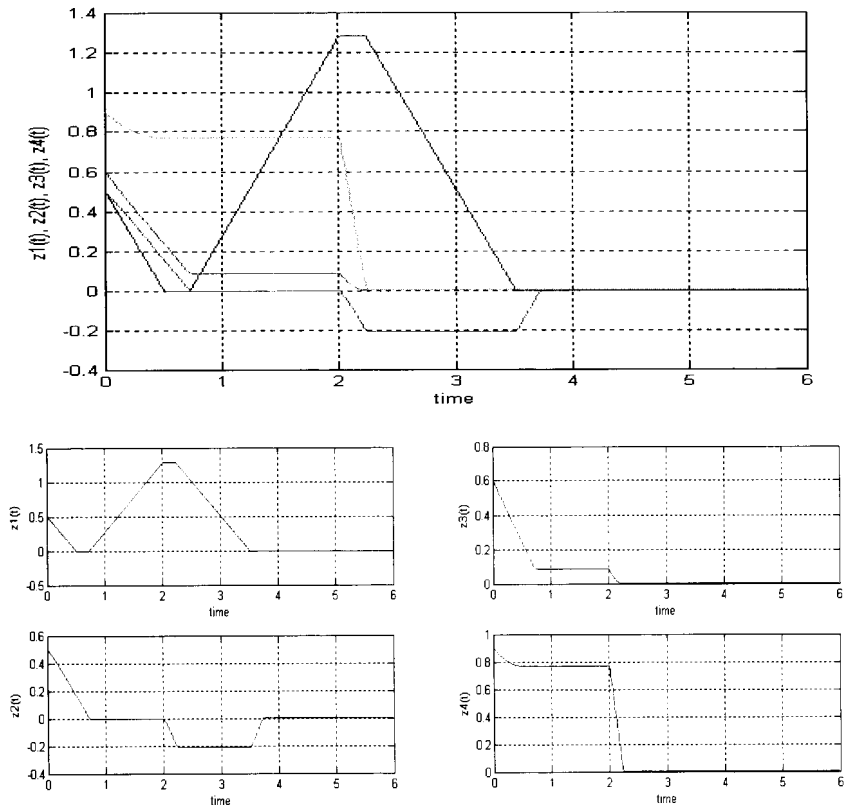


**Figure 5a:** Plots of the controlled state trajectories  $t \mapsto (z_1(t), \dots, z_4(t))$  versus time.

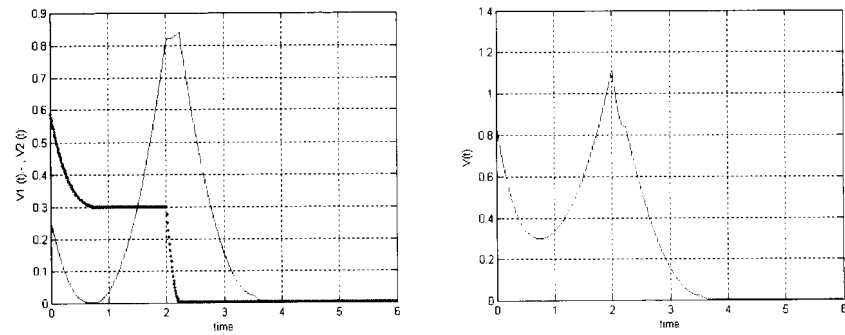


**Figure 5b:** Plots of the functions  $V_1(t)$  &  $V_2(t)$  , and  $V(t)$  versus time.



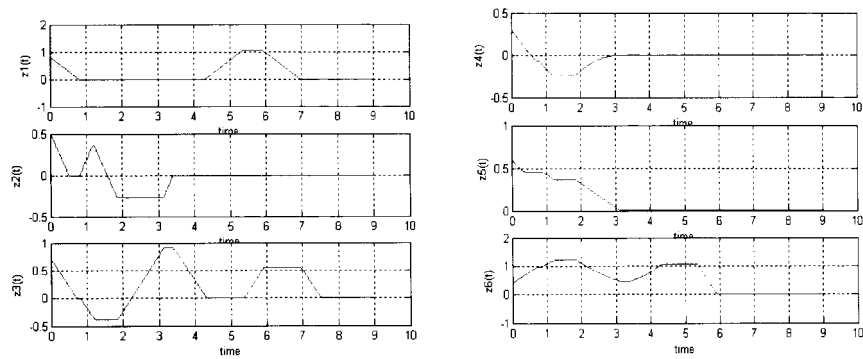
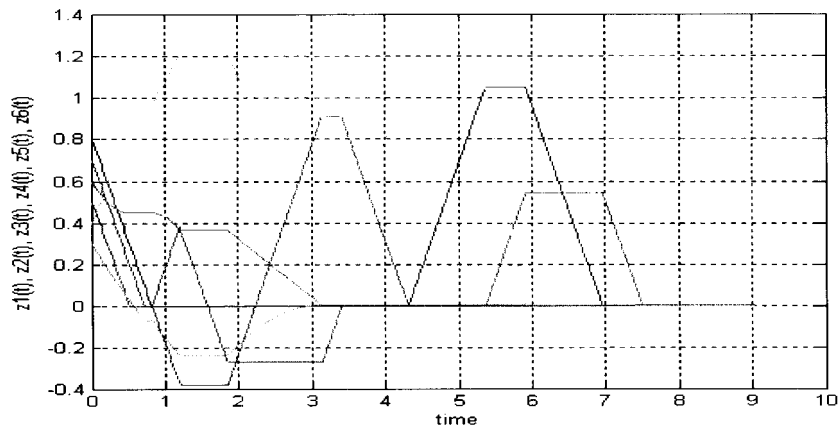


**Figure 5c:** Plots of the controlled state trajectories  $t \mapsto (z_1(t), \dots, z_4(t))$  versus time.

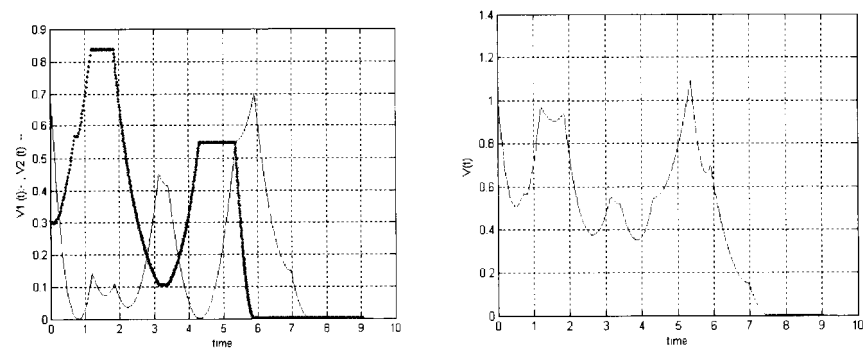


**Figure 5d:** Plots of the functions  $V_1(t)$  &  $V_2(t)$  , and  $V(t)$  versus time.

**Simulation results of Example 3(The fire truck model)**



**Figure 6a:** Plots of the controlled state trajectories  $t \mapsto (z_1(t), \dots, z_6(t))$  versus time.



**Figure 6b:** Plots of the functions  $V_1(t)$  &  $V_2(t)$ , and  $V(t)$  versus time.

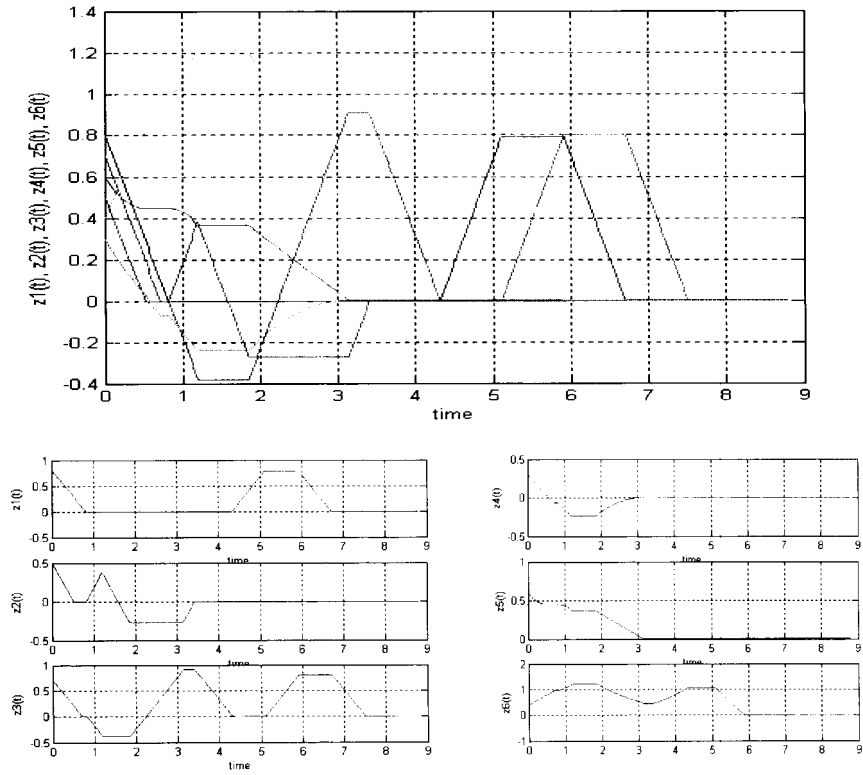


Figure 6c: Plots of the controlled state trajectories  $t \mapsto (z_1(t), \dots, z_6(t))$  versus time.

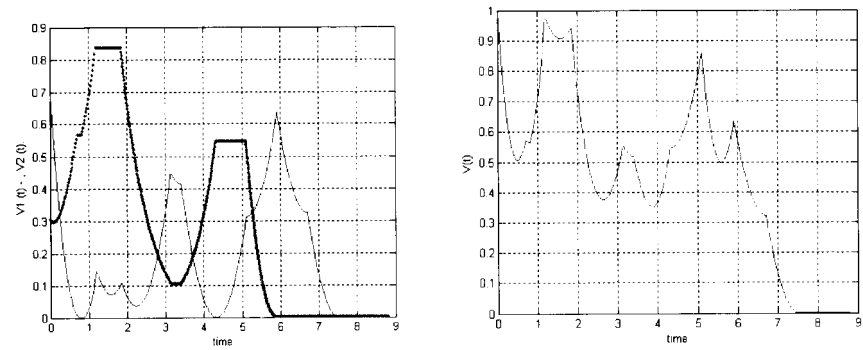
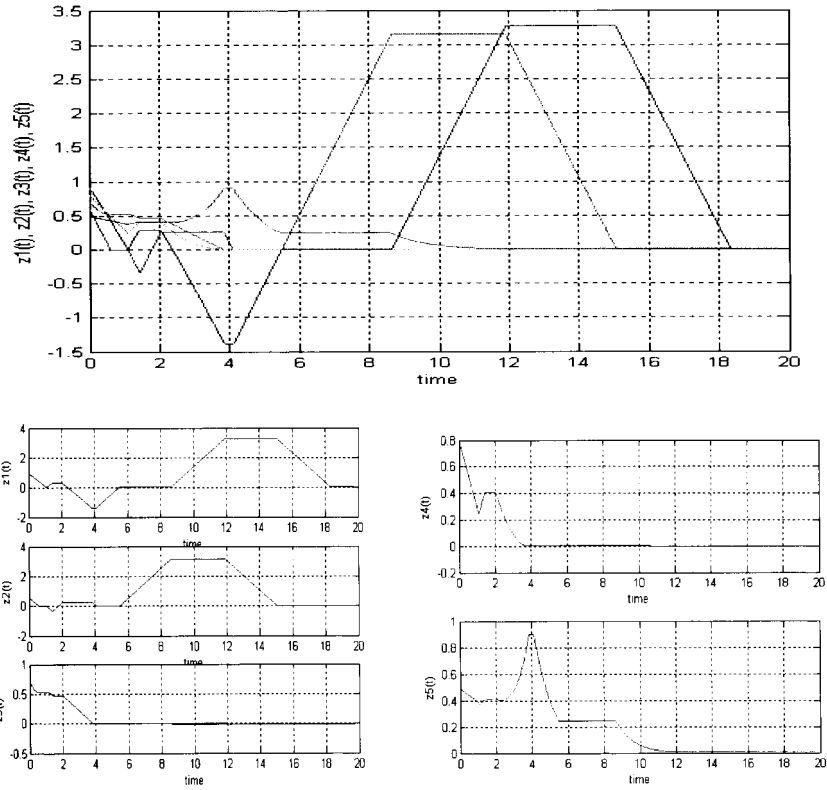
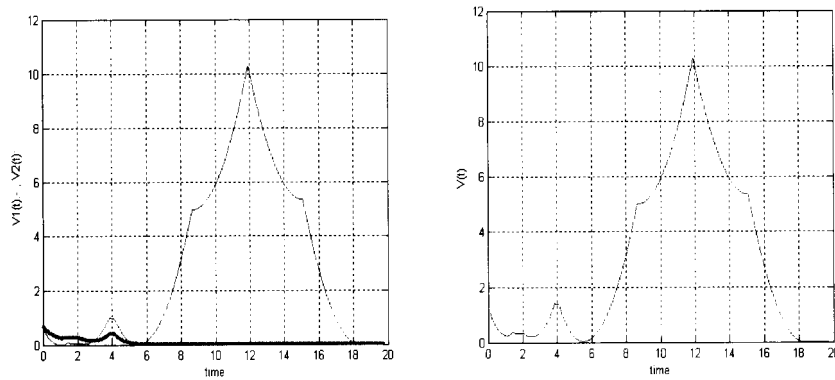


Figure 6d: Plots of the functions  $V_1(t)$  &  $V_2(t)$ , and  $V(t)$  versus time.

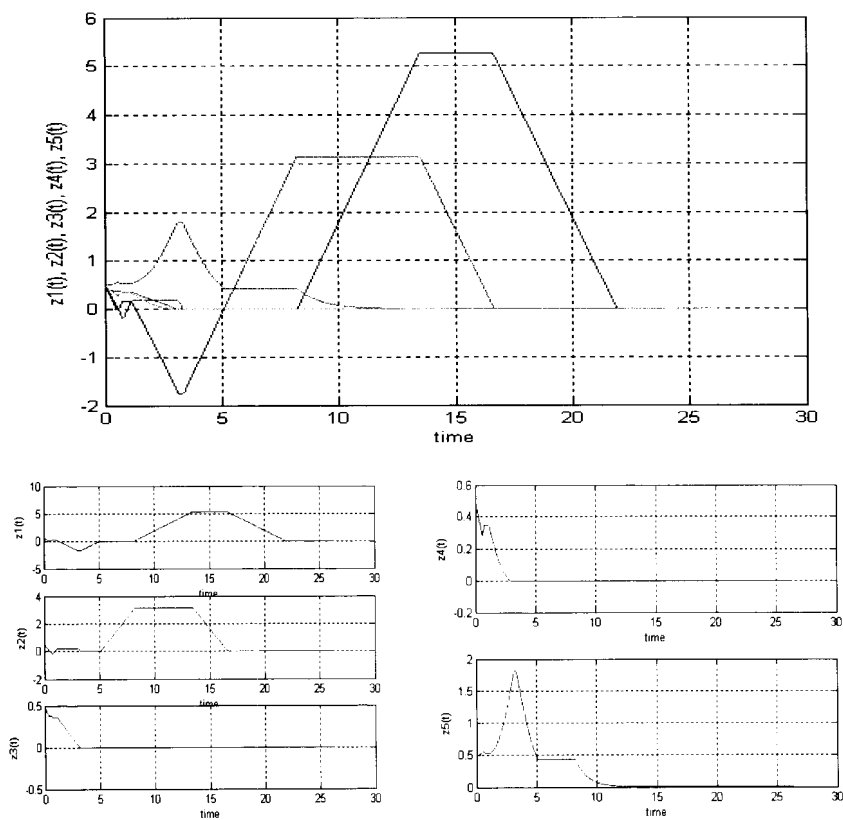
**Simulation results of Example 4 (The mobile robot with trailer model)**



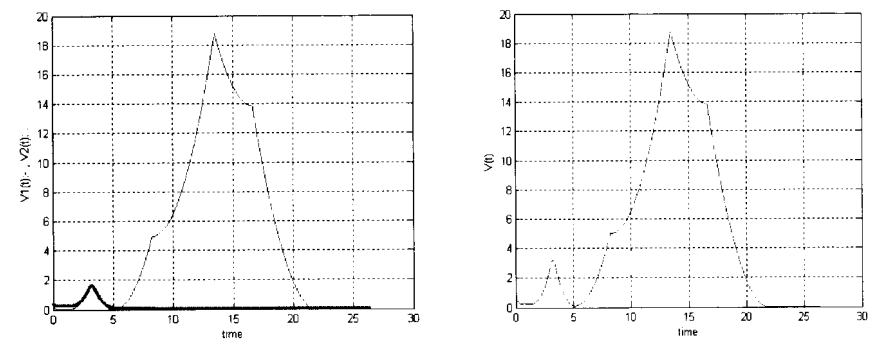
**Figure 7a:** Plots of the controlled state trajectories  $t \mapsto (z_1(t), \dots, z_5(t))$  versus time.



**Figure 7b:** Plots of the functions  $V_1(t)$  &  $V_2(t)$  , and  $V(t)$  versus time.



**Figure 7c:** Plots of the controlled state trajectories  $t \mapsto (z_1(t), \dots, z_5(t))$  versus time.



**Figure 7d:** Plots of the functions  $V_1(t)$  &  $V_2(t)$ , and  $V(t)$  versus time.

